

Monday, March 16th

Go outside and sit quietly for a little while. What sounds do you hear? Draw a picture or write down all of the things that you hear. Are they loud or soft? Do they have a high pitch or a low pitch?

March 17th - St. Patrick's Day

Celebrate the music and dancing of Ireland with these fun videos!

<https://www.youtube.com/watch?v=UklnEUrfW7w>

Irish Jig

https://www.youtube.com/watch?v=pmc0m1xP_v0

Irish Step Dancing

<https://www.youtube.com/watch?v=vh9i6vf0TIU>

Irish Music and Step dancing

https://www.youtube.com/watch?v=iHxGisr7a_l&t=45s

Irish Jig Instructional Video

March 18th

Learn all about the instruments of the orchestra!

Zin Zin Zin a Violin Read-along

https://www.youtube.com/watch?v=2uXZj_zs9fY

The Remarkable Farkle McBride Read-along

Find out what instrument Farkle likes best!!

<https://www.youtube.com/watch?v=oM5pmq5nr1Q>

March 19th

Visit the Dallas Symphony Orchestra website about instruments. Choose one or two instruments from each family. Listen to the special sound that each one makes. What is your favorite?

<https://www.mydso.com/dso-kids/learn-and-listen/instruments>

March 20th

Peter and the Wolf by Sergei Prokofiev

Learn about the composer who wrote this famous musical story.

<https://www.mydso.com/dso-kids/learn-and-listen/composers/sergei-prokofiev>

Discover how composers can use music to tell a story. What instruments were used for each character?

<https://www.youtube.com/watch?v=m2ed6EcTxrU>

March 23rd - BRAIN BREAK

Give yourself a brain break and enjoy dancing along to some of these kid-friendly videos.

Just Mario - <https://www.youtube.com/watch?v=dV12OqloNFs>

I Like to Move It - <https://www.youtube.com/watch?v=ziLHZekbMUo>

Dynamite -

https://www.youtube.com/watch?v=eughyYPoExk&list=RDeughyYPoExk&start_radio=1

Despicable Me - <https://www.youtube.com/watch?v=NbDfTSordh8>

Popsico 2 - <https://www.youtube.com/watch?v=Pwn4beja1QE>

Milkshake - <https://www.youtube.com/watch?v=dNL6RwymoNg>

Trolls: Can't Stop the Feeling -

<https://www.youtube.com/watch?v=KhfkYzUwYFk>

Hip-Hop Tooty Ta - <https://www.youtube.com/watch?v=MwoTsWiz60I>

What Makes You Beautiful -

<https://www.youtube.com/watch?v=bjtWjGpPjqc>

Larger than Life - <https://www.youtube.com/watch?v=yozTYHv7PLs>

March 24th - EXPLORE THE WEB

Discover, listen, play, perform, conduct and compose on the San Francisco Orchestra Website for kids.

<http://www.sfskids.org/>

Visit Classics for Kids to listen, learn and play some fun music games.

<https://www.classicsforkids.com/>

March 25th

2nd grade - *Bim Bum* Clapping Game

Challenge your coordination skills with this fun singing game.

<https://www.youtube.com/watch?v=aXZWgOf2ISA>

K & 1st - Clap and pat along with this fun rhythm exercise

<https://www.youtube.com/watch?v=jz6yP5r0e0A>

March 26th

Watch *I've Got Rhythm* to learn more about reading rhythm.

<https://www.youtube.com/watch?v=RYsGINpx2YI&t=174s>

March 27th

Improve your rhythm reading skills with these easy rhythm exercises.

K & 1st -

<https://www.youtube.com/watch?v=4vZ5mlfZlgk&list=PL3vpgblqifNJmdul6UNYwvhAL2YhaRq9H>

2nd grade - <https://www.youtube.com/watch?v=cHad-I5AJT0>

<https://www.youtube.com/watch?v=rf5rcXhGPps>

String Family

Name: _____

Color the instruments of the string family.

Class: _____

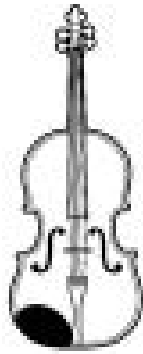

violin



viola



cello

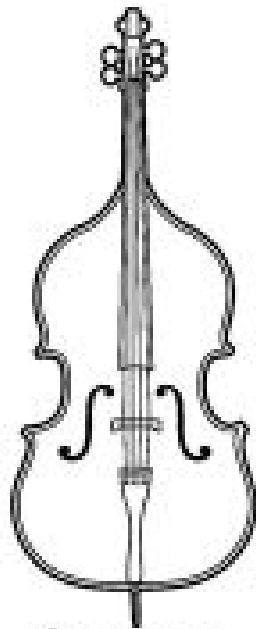

bass

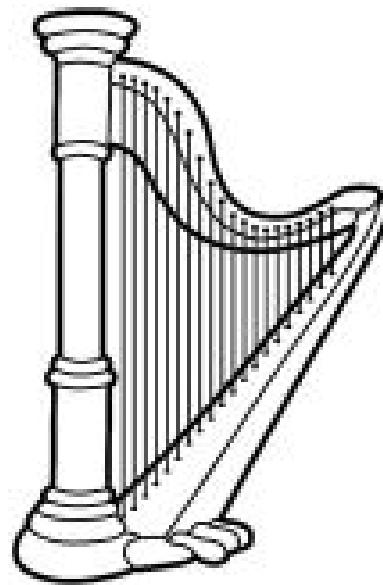

harp

Woodwind Family

Name: _____

Color the instruments of the woodwind family.

Class: _____

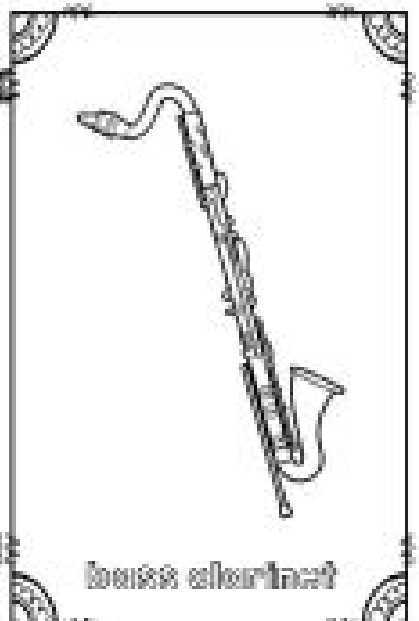
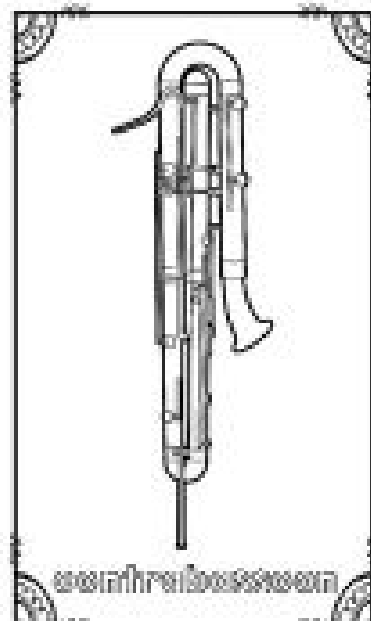
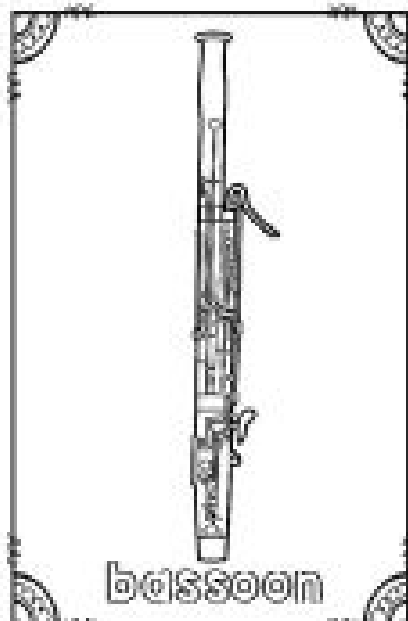
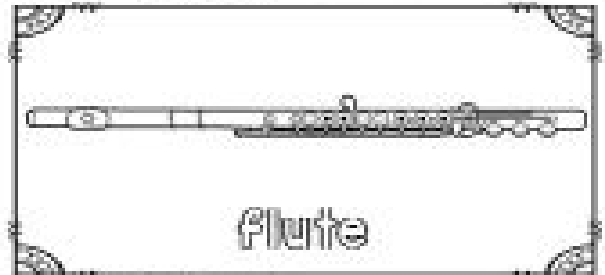
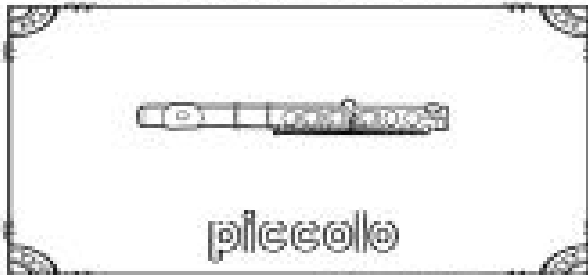

Brass Family

Name: _____

Color the instruments of the brass family.

Class: _____

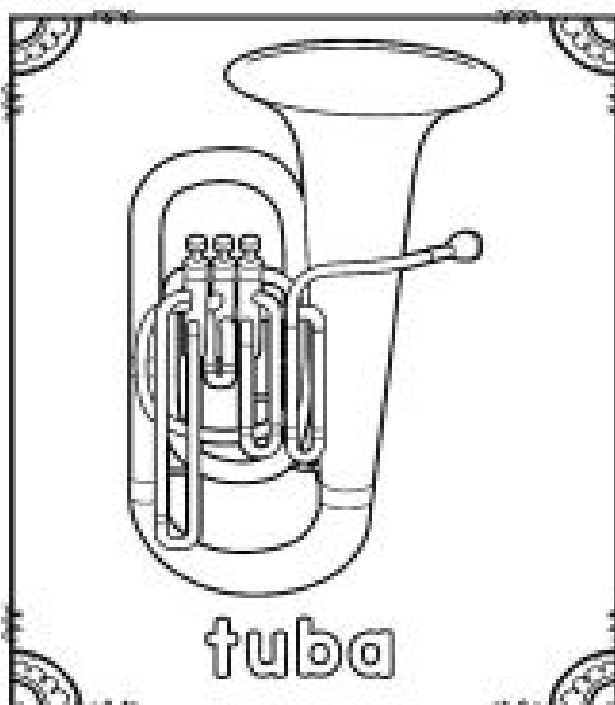

Percussion Family

Name: _____

Color the instruments of the percussion family.

Class: _____

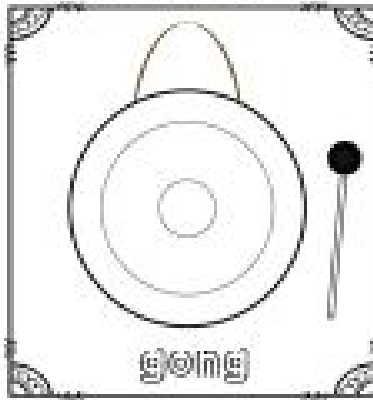

Name _____

Class _____

Color By Note

Color the circles with quarter notes in them blue.

Color the circles with pairs of eighth notes in them green.

Color the circles with quarter rests in them red.

